

# NH12-185W

## 12V 185W/15min



### Introduction

**E-GUARD NH (high rate) series** is primarily for heavy load discharge in short time backup especially in UPS applications. Designed with a high-density plate technology, this series of battery features high consistency, excellent performance and reliable standby service life.

### Battery Features

- High rate output aimed at the UPS market
- Low self-discharge
- Fully tank formed plates
- Low impurity electrolyte
- Spill proof / leak proof
- Multi-position usage
- ABS case and cover VO upon request
- Very high purity lead

### Electrical Specification

Design floating Life @ 25°C (77°F)	10 years
Nominal Capacity @ 25°C /77°F	
Watt @ 15min to 1.67V/cell	185 W/cell
Watt @ 10min to 1.67V/cell	232 W/cell
Internal Resistance	
(Fully charged battery @ 25°C /77°F)	6mΩ
Max. Discharge Current @ 25°C /77°F	620A (5S)
Charge Methods: Constant voltage charge @ 25°C /77°F	
Cycle Use	14.7 ~ 14.9V
Max. Current	10.2A
Standby Use	13.6 - 13.8V
Operating Temperature Range	-30 ~ 50°C

Notes: battery voltage must be adjusted according to temperature.

Effect of temperature on float charge voltage:  $-3mV/^\circ C/Cell$ .

Self-Discharge	3% of capacity declined per month @ 25°C (77°F).
----------------	--

### Typical Applications

- UPS/EPS (High rate)
- Emergency lighting
- High power backup supply
- Electric starting

### Maintenance & Caution

Every three months, recommend equalization charge for one time.  
Equalization charge method: constant voltage charge at 14.4-14.7V for 24h.

Terminal	T3, T5, T10	T4, T6, T7, T11, T12	T8, T13, T14, T16
Bolt	M5	M6	M8
Torque	5-6N*m	9-11N*m	11-13N*m

### Certificates



### Battery Picture & Terminal Layout

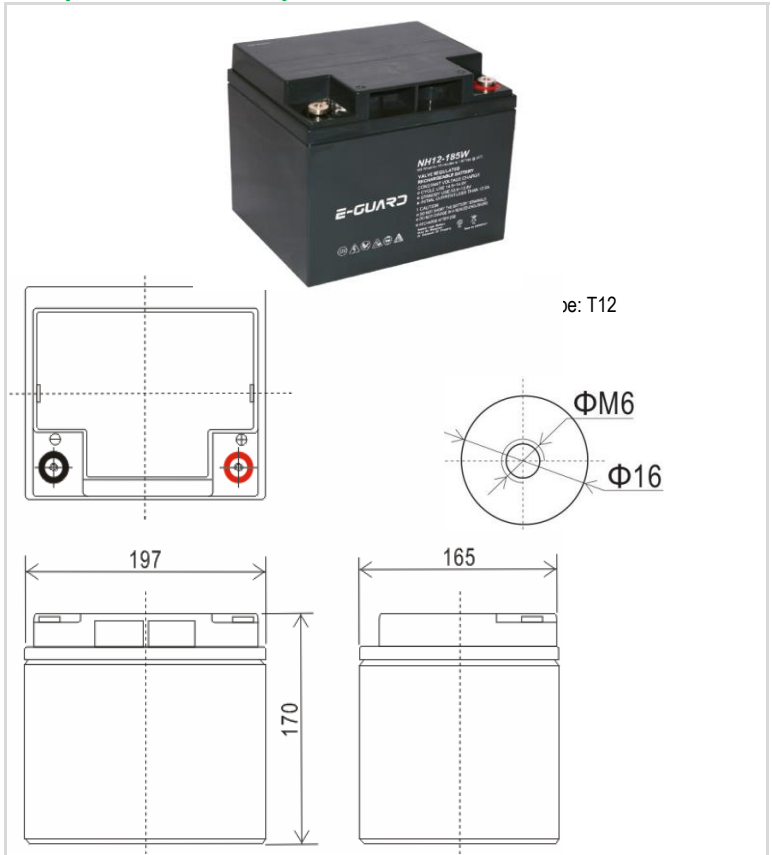

### Dimension & Weight

	Dimension (± 2mm)				Weight (± 2%)
	Length	Width	Height	Total Height	
	197 mm	165 mm	170 mm	170 mm	14.0 kg
	7.8 inch	6.5 inch	6.7 inch	6.7 inch	30.9 lbs

### Constant Current Discharge (Amperes @ 25°C /77°F)

V/cell	5min	10min	15min	20min	30min	45min	55min	1hr	2hr
1.60	190.00	116.88	90.38	77.66	55.98	40.94	38.18	32.22	19.55
1.65	182.20	112.55	89.85	76.07	55.38	40.87	37.30	31.84	19.51
1.70	178.03	110.51	88.33	75.95	55.01	40.78	37.18	31.71	19.37
1.75	161.38	105.61	85.43	74.14	54.52	40.69	37.02	31.64	19.19
1.80	144.58	97.21	80.93	70.78	52.90	39.72	35.84	31.19	19.02

### Constant Power Discharge (Watts/cell @ 25°C /77°F)

V/cell	5min	10min	15min	20min	30min	45min	55min	1hr	2hr
1.60	389.1	238.9	187.9	159.10	117.13	83.77	78.15	67.98	38.74
1.65	379.4	236.8	186.4	158.12	116.68	83.09	75.26	67.75	37.88
<b>1.67</b>	<b>371.6</b>	<b>232.0</b>	<b>185.0</b>	<b>155.35</b>	<b>114.85</b>	<b>82.92</b>	<b>73.88</b>	<b>67.35</b>	<b>37.17</b>
1.70	354.9	226.1	183.0	154.05	113.41	81.50	72.12	66.42	35.99
1.75	343.6	218.4	181.5	150.77	112.51	80.76	69.60	65.19	34.73
1.80	304.1	201.5	171.4	146.78	112.12	79.65	68.59	63.62	33.97

Above discharge data is average values after batteries are fully charged.

Subject to revision without notice. Please contact our sales representatives for latest version.

Web: [www.enervision.co.za](http://www.enervision.co.za) | Email: [sales01@enervision.co.za](mailto:sales01@enervision.co.za) | Telephone: 0861 111 270

VERSION:20200519



# NH12-185W

## 12V 185W/15min

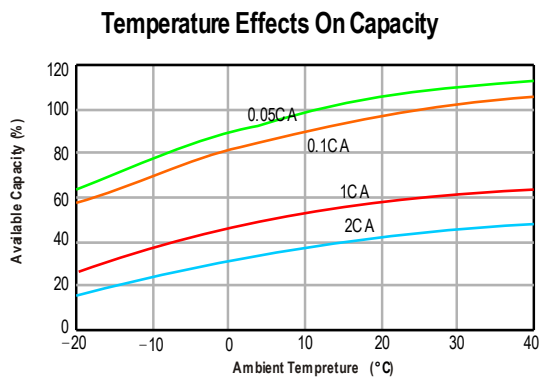
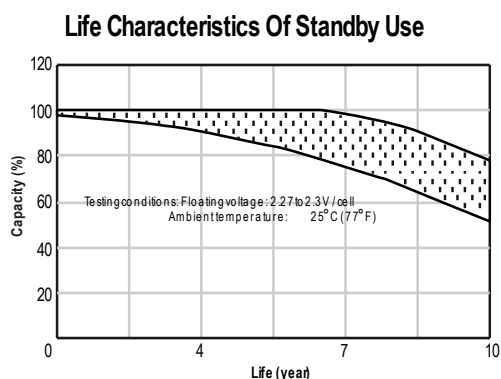
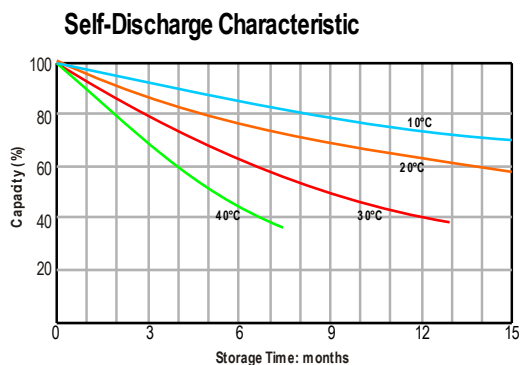
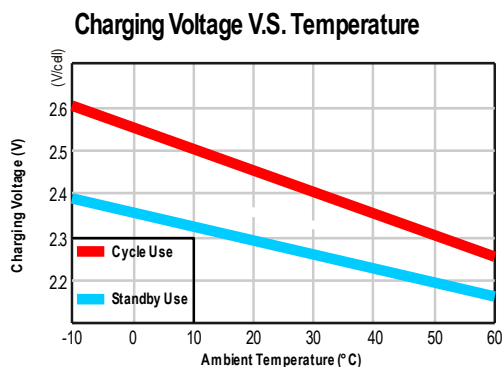
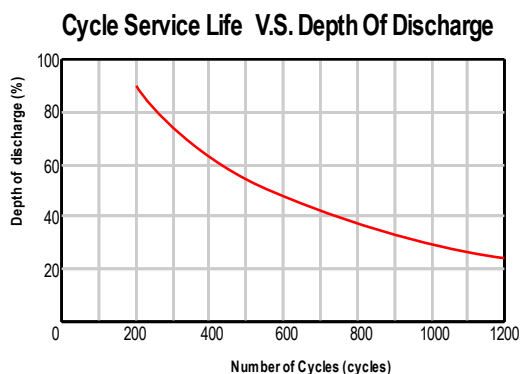
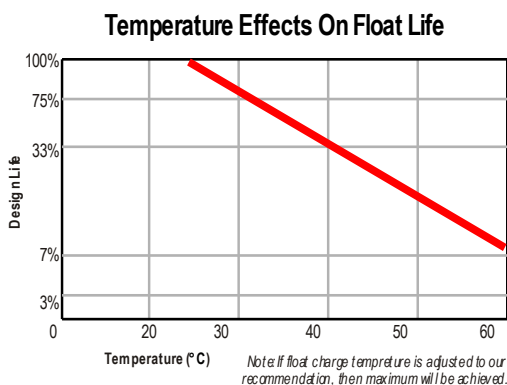
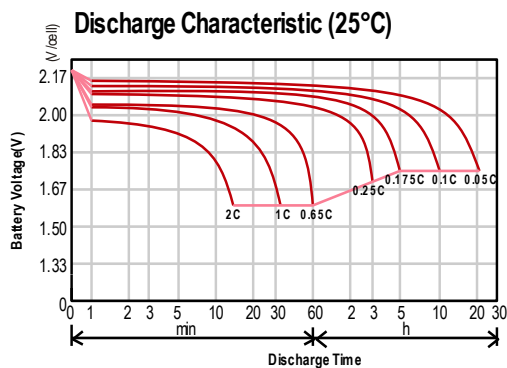
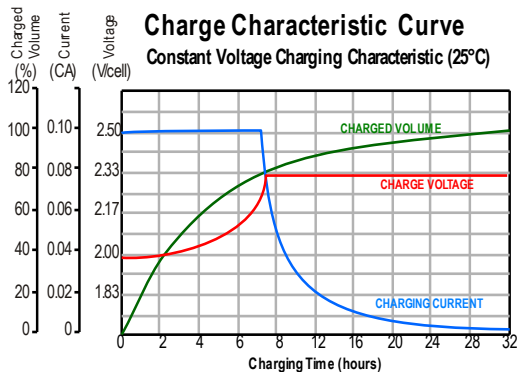

Subject to revision without notice. Please contact our sales representatives for latest version.

Web: [www.enervision.co.za](http://www.enervision.co.za) | Email: [sales01@enervision.co.za](mailto:sales01@enervision.co.za) | Telephone: 0861 111 270

VERSION:20200519